

Catalog

## Torch-Cleaning-Stations and additional products for welding robots

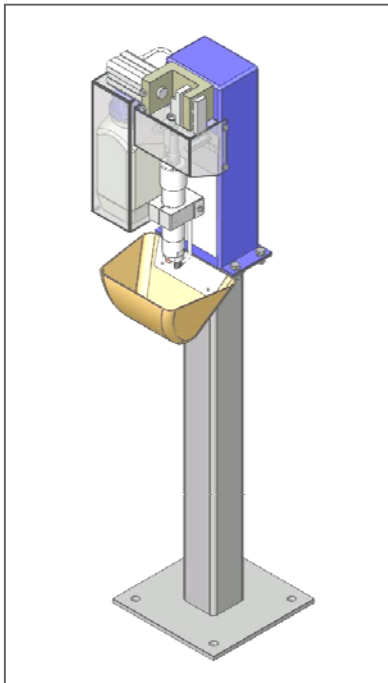

**J. Thielmann  
Gesellschaft fuer  
Automatisierungstechnik mbH**

Distributed by:

Welding Automation Pty Ltd  
t:+61 3 8516 2742 f:+61 3 9011 6203 e:sales@weldingautomation.com.au

Contents

Page

---

Torch-Cleaning-Station BRG-2000 D.....	3
Wire-Cutter DA-2000 E.....	3
Support for Torch-Cleaning-Station .....	4
Reamers.....	4
Pressure Amplifier DV-10.....	5
Options for Torch-Cleaning-Station .....	5
Contact.....	6

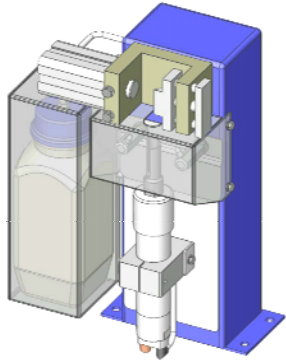
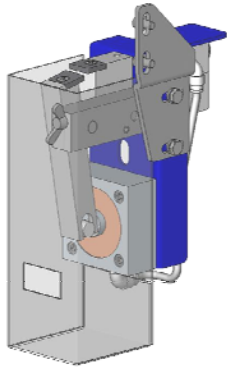
<b>Torch-Cleaning-Station BRG-2000 D</b>	Art.-no. 200600/D	
<b>Basis unit</b> <ul style="list-style-type: none"><li>- Venturi principle</li><li>- Limit switch clamp cylinder open</li><li>- Reamer x/x mm</li><li>- Gas nozzle fixing piece for various gas nozzle diameters</li><li>- Spraying through separate Spray nozzles</li><li>- Bottle for anti spatter fluid, 1 litre</li><li>- Electrical connection 4-pole</li><li>- Bowl for waste with holder</li><li>- Automatic electro-pneumatic cycle</li></ul>		
<b>Wire-Cutter DA-2000 E</b>		Art.-no. 201030
<ul style="list-style-type: none"><li>- Actuated electrical 24VDC</li><li>- Air pressure 6bar / 87psi</li><li>- Including housing for cut reminders</li></ul>		

**Support BRG-2000**

Art.-no. 890087

- Height 680mm
- Colour black
- Powdercovered

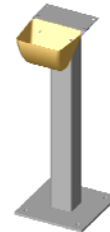
**Support BRG-2000 adjustable**

Art.-no. 890100

- Adjustable 880-1500mm
- Colour black
- Powdercovered

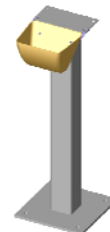



**Reamer**

Art.-no. 6000x/x

Gasdüse/ID Gas nozzle/ID	Stromdüse/AD Welding tip/OD	Fräser/AD Reamer/OD	Fräser/ID Reamer/ID	Bestell-Nr. Ref.-no.
10 mm	6 mm	9,5 mm	6,5 mm	60009,5/6,5
11 mm	6 mm	10,5 mm	7 mm	600010,5/7
11 mm	8 mm	10,5 mm	8,5 mm	600010,5/8,5
12 mm	8 mm	11 mm	8,5 mm	600011/8,5
12,5 mm	8 mm	11,5 mm	8,5 mm	600011,5/8,5
13 mm	6 mm	12 mm	7 mm	600012/7
13 mm	8 mm	12 mm	8,5 mm	600012/8,5
13 mm	8 mm	12 mm	9 mm	600012/9
13 mm	9 mm	12 mm	9,5 mm	600012/9,5
13 mm	8 mm	12,5 mm	9 mm	600012,5/9
14 mm	6 mm	13 mm	7 mm	600013/7
14 mm	8 mm	13 mm	9 mm	600013/9
15 mm	8 mm	14 mm	9 mm	600014/9
15 mm	10 mm	14 mm	11 mm	600014/11
15,5 mm	10 mm	14,5 mm	11 mm	600014,5/11
16 mm	10 mm	15 mm	11 mm	600015/11
17 mm	10 mm	16 mm	11 mm	600016/11
18 mm	10 mm	17 mm	11 mm	600017/11
18 mm	12 mm	17 mm	13 mm	600017/13
19 mm	10 mm	18 mm	11 mm	600018/11
20 mm	10 mm	19 mm	11 mm	600019/11
21 mm	12 mm	20 mm	13 mm	600020/13

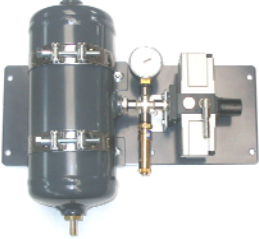

j.thielmann®

<b>Pneumatic Amplificator DV-10</b>	Art.-no. 160103	
<ul style="list-style-type: none"> <li>- Blowing from behind through the robot torch</li> <li>- Amplification factor 1:2</li> <li>- Input: 6 bar / 87 psi</li> <li>- Output: 12 bar / 174 psi</li> <li>- Output pressure adjustable</li> <li>- Without control valve blowing out</li> </ul> <b>Option:</b> Solenoid valve (Art.-no. 200368 )		
<b>Option Air bleed valve</b>	Art.-no. 200943	
<ul style="list-style-type: none"> <li>- Manual air interruption</li> </ul>		
<b>Option Maintenance unit</b>	Art.-no. 890108	
<ul style="list-style-type: none"> <li>- 1/4" connection</li> <li>- Lubricator function</li> <li>- Water separator function</li> </ul>		
<b>Option Dirt pan BRG</b>	Art.-no. 890102	
<ul style="list-style-type: none"> <li>- Measures 400x400mm</li> <li>- Colour black</li> <li>- Powdercovered</li> </ul>		

j.thielmann®

---

Contact



**J. Thielmann  
Gesellschaft fuer  
Automatisierungstechnik mbH**

In Australia: Welding Automation Pty Ltd

t: +61 3 8516 2472 f: +61 3 9011 6203 e: [Sales@WeldingAutomation.com.au](mailto:Sales@WeldingAutomation.com.au)